

NP10PP60F80

Specification:

- Type: PP Transformer
- Power: 60W
- Impedance primary (Zprim): 10k
- Impedance output (Zout): 8Ω/16Ω
- Bandwidth (-2dB): 10Hz - 80kHz
- Current (DC): 120 mA
- Volgate (DC): max 1000V
- Core: Amorphous
- Dimension L×W×H (mm): 100×60×110
- Weight: 2.5kg/ each

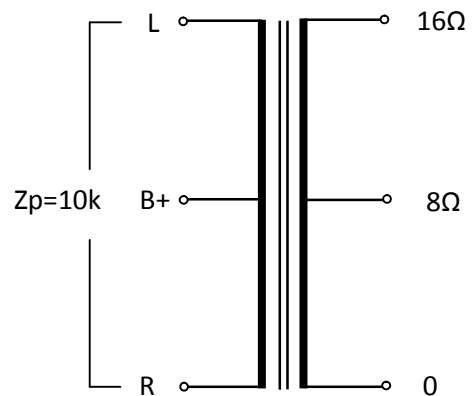

Physical dimensions detail (mm)

